



DELHI AVIATION FUEL FACILITY PRIVATE LIMITED

**DELHI AVIATION FUEL FACILITY PRIVATE LIMITED
AVIATION FUELLING STATION
SHAHBHAD MOHAMMADPUR
IGI AIRPORT
NEW DELHI-110061**



TENDER NO: DAFFPL/FF/2022-23/02

INVITING TENDER FOR
SUPPLY of 16" EXPANSION JOINT (TIED DOUBLE METAL
BELLOW EXPANSION JOINT)

BID DUE DATE & TIME: 1500 Hrs. IST on 7th June 2022

OPENING OF TECHNICAL BIDS: 1100 Hrs. IST on 8th June 2022



Contents

CHAPTER 1: Introduction (COVERING NOTE)04

CHAPTER 2: INSTRUCTIONS TO BIDDERS.....09

CHAPTER 3: BID-QUALIFICATION CRITERIA 14

CHAPTER 4: PERFORMANCE OF WORK 18

CHAPTER 5: SCOPE OF WORK23

CHAPTER 6: GENERAL TERMS & CONDITIONS23

Annexure I – Technical Specifications/Material Requisition

Annexure II – DEVIATION SHEET TO BE SUBMITTED ALONGWITH Technical BID

Annexure III – DECLARATION SHEET TO BE SUBMITTED ALONGWITH Technical BID

Annexure IV – FORMAT FOR DRAFT BANK GUARANTEE IN LIEU OF BID SECURITY (EMD)

Annexure V - FORMAT DRAFT COMPOSITE BANK GUARANTEE FOR SECURITY DEPOSIT/PERFORMANCE GUARANTEE

Annexure VI – FORM OF LETTER OF UNDERTAKING

Annexure VII – DECLARATION TO BE SUBMITTED ALONGWITH Technical BID

Annexure VIII – STATEMENT OF CEREDENTIALS TO BE SUBMITTED ALONGWITH Technical BID

PRICE BID FORMAT

NOTE: BIDDERS ARE REQUESTED TO SIGN AND STAMP ALL THE PAGES OF THE TENDER DOCUMENT AND SEND THE SAME BACK IN THEIR OFFER AS A TOKEN OF UNCONDITIONAL ACCEPTANCE OF TENDER TERMS.

THE DEVIATIONS, IF ANY, SHOULD BE MENTIONED SEPARATELY ON BIDDER’S LETTER HEAD IN TECHNICAL BID. THE DEVIATIONS MENTIONED ANYWHERE ELSE SHALL NOT BE CONSIDERED. IN ABSENCE OF DEVIATION SHEET, IT WOULD BE CONCLUDED THAT BIDDER HAS ACCEPTED THE TENDER TERMS WITHOUT ANY DEVIATIONS. CORRECTIONS IN TENDER DOCUMENT WILL NOT BE ACCEPTED.



DELHI AVIATION FUEL FACILITY PRIVATE LIMITED

TENDER NOTICE DELHI AVIATION FUEL FACILITY PRIVATE LIMITED

INVITING TENDER FOR SUPPLY of 16" EXPANSION JOINT (TIED DOUBLE METAL BELLOW EXPANSION JOINT) AS PER SPECIFICATIONS

TENDER NO: DAFFPL/FF/2022-23/02

Delhi Aviation Fuel Facility (P) Ltd (DAFFPL) invites bids from eligible bidders for supply of EXPANSION JOINT (TIED DOUBLE METAL BELLOW EXPANSION JOINT).

Brief Scope of work:

We intend to provide EXPANSION JOINT (TIED DOUBLE METAL BELLOW EXPANSION JOINT) as Tank Body Valves. The valves shall be suitable for continuous use in Liquid hydrocarbon product, viz. Jet fuel.

Bid Security (EMD):	As mentioned in the Tender document
Date, Time & Venue for Voluntary Pre-bid Meeting:	20 th May 2022; 1100 HRS (IST) at DAFFPL, Aviation Fueling Station, Shahabad Mohammadpur, New Delhi-110061
Last Date of Submission of Queries	Upto 18:00 HRS (IST) on 27 th May 2022.
Bid Due Date, Time & Place of Submission:	Upto 15:00 HRS (IST) on 7 th June 2022, at e-Tendering Portal of DAFFPL

Detailed Invitation for Bids (IFB) along with Pre-qualification Criteria, Bid Document Corrigenda can be viewed and downloaded from DAFFPL's website: <http://www.daffpl.enivida.com>.

Chief Executive Officer
DAFFPL, New Delhi



CHAPTER 1: INTRODUCTION (COVERING NOTE)

Delhi Aviation Fuel Facility Private Limited (DAFFPL) is a Joint Venture comprising Indian Oil Corporation Ltd. (IOCL), Bharat Petroleum Corporation Ltd. (BPCL), and Delhi International Airport (P.) Ltd. (DIAL). We provide the infrastructure aimed at ensuring an uninterrupted flow of Aviation Turbine Fuel (ATF) to all type of aircrafts at the Indira Gandhi International Airport, New Delhi (IGI Airport) as per international benchmarking.

The bidder/ contractor shall refer to various sections of this tender document for detailed scope of work. It is contractor's/ bidder's responsibility to execute the job in all respects as per specification furnished by consultant / owner and as per applicable codes, standards & in line with statutory requirements.

The field circumstances shall also be taken into consideration and methods suitable to the site conditions shall be adopted with concurrence of the Engineer-in-charge and in line with manuals, instructions of respective equipment and specified codes and standards. The successful accomplishment of the project is greatly influenced by the teamwork, workmanship of the workers and supervisors.

The Contractor/Bidder shall employ only such workers and supervisors who have considerable experience of similar work and who can work, temperamentally in good harmony and co-operation.

Delhi Aviation Fuel Facility Private Limited (DAFFPL) invites tenders in prescribed tender form under two-bid system. For viewing details including EMD, BID QUALIFICATION CRITERIA etc. please visit our e-Tendering web site <http://daffpl.enivida.com>

The bids are to be submitted on the e-Tendering portal of **Delhi Aviation Fuel Facility Private Limited (DAFFPL)**.



DELHI AVIATION FUEL FACILITY PRIVATE LIMITED

1. The Tender is floated in Two Bid system consisting of Technical Bids (Bid Qualification Criteria - BQC, Technical plus Commercial) and Price Bids.

Part-I : Bid Security / EMD in accordance with tender document.
Part-II : BQC (Bid qualification criteria), Technical & commercial Bid, duly filled in & along with all supporting as requested to be submitted/uploaded on DAFFPL e-tendering portal.
Tender Box.
Part -III : Price Bid.

2. The bidder should be able to construct the entire size/type/quantity bid by them. Bidders cannot bid for part items or part quantity.
3. Firstly, the technical bid (BQC & Techno commercial bids) shall be opened. The Bids shall be initially scrutinized by a team as per tender requirements of BQC (Bid qualification criteria). Technical cum commercial bids of only those vendors who qualify the BQC will be processed further. The price bids of only techno-commercially qualified bidders will be opened, evaluated and shortlisted for Placement of Work Order.
4. The bids submitted should be valid for **four months** from the due date of bid submission for Owner's acceptance. Once accepted it will remain firm till completion of contracts/orders.
5. We request the bidder to carefully go through all tender documents before submitting the offer. Please note that any exceptions or deviations to the tender document are necessarily to be recorded in the attached deviation statement only. Any exceptions/deviations brought out elsewhere in the bid shall not be considered.
6. The bidders may be invited for a presentation to DAFFPL during Techno-commercial evaluation before price bid opening.
7. The bidders to provide their bank details/ PAN / Goods & Service Tax Registration No. / VAT registration No., as applicable for updating vendor master file. You are also requested to keep us informed of any change in address / status of your business / contact details including email address etc.
8. Party can quote with the deviations as referred in Point No.5 above. Please refer query end date / time in tender calendar after which no query posted by bidder shall be considered. However, DAFFPL reserves the right to respond the queries after cutoff date / time mentioned in tender calendar.



DELHI AVIATION FUEL FACILITY PRIVATE LIMITED

9. Please note that queries related to scope of job, tender specifications, terms & conditions etc., should be submitted online before the query closing date. Any modification in the bid document that may become necessary as a result of the Pre-Bid meeting shall be made by the owner exclusively through the issues of corrigendum/ addendum posted at e-tender portal.

10. UNSOLICITED POST BID MODIFICATION

Bidders are advised to quote strictly as per terms and conditions of the Bidding Document. After tender submission due date & time/ extended due date & time (as the case may be) the bidders shall not make any subsequent price changes, whether resulting or arising out of any technical / commercial clarifications sought/allowed on any deviations or exceptions mentioned in the bid.

11. EMD & Techno Commercial bid shall be opened on or after the date mentioned on tender opening date on e-tender portal. Price Bid of only those bidders whose offer is found meeting both BQC & techno-commercially acceptable, shall be opened on a later date as decided by DAFFPL.

12. DAFFPL reserves the right to accept any one or more tender in whole or in part or reject any or all tenders without assigning any reason. DAFFPL reserves right to accept any or more tenders in part. Decision of DAFFPL in this regard shall be final and binding on the bidder.

QUERIES AND CLARIFICATIONS: Any query or clarification with regard to this tender may please be referred to below address & phone nos. on any working day during office working hours.

Mr. Ajay Singh, Asst. Manager Projects, ajay.singh@daffpl.in , 9999946309,	Mr. Manish Kumar Project Officer manish.kumar@daffpl.in , 9810640818	vishvajit@daffpl.in
---	---	--

13. GOVERNING LAWS: The laws of Union of India shall govern all matters concerning the tender. Any issue arising related to the tender, or the selection process shall be adjudged by the courts in Delhi alone.

14. A Pre-bid meeting shall be conducted is scheduled for **20th May 2022 at 1100 Hrs IST** at the office of DAFFPL, New Delhi. All prospective bidders can participate in the same. Any clarification regarding tender shall be sorted out during the pre-bid meeting.

a. The purpose of the pre-bid meeting is to clarify any doubts of the



DELHI AVIATION FUEL FACILITY PRIVATE LIMITED

BIDDER on the interpretation of the provisions of tender.

- b. Bidder(s) are requested to submit their queries, mentioning form name, clause no. & clause through e-tender portal as per schedule in order to have fruitful discussions during the meeting.
- c. All the Bidder(s) are requested to attend the pre-bid meeting to be held at DAFFPL Office as per schedule.

15. **Earnest Money Deposit (EMD) (also referred to as Bid Security):** Bidder shall be required to submit the Earnest Money Deposit (EMD), either in the form of Bank guarantee as per format (provided as Annexure) or bank transfer (IMPS/RTGS) in favor of Delhi Aviation Fuel Facility Private Limited. The EMD in either form has to be submitted on or before the due date & due time of bid submission of this tender with a covering note mentioning the tender no.

Direct bank transfer for Tender Fee and Earnest Money Deposit to DAFFPL account as detailed below. The UTR Reference and date shall be provided in the Tender portal for DAFFPL verification.

Name of Account	DELHI AVIATION FUEL FACILITY PRIVATE LTD.
Account No.	39040531887
Name of Branch	Corporate Accounts Group-II Branch, New Delhi
IFSC Code	SBIN0017313
SWIFT	SBININBB824
MICR	110002562
PAN	AAACS8577K
TAN	DELS55939C
BSR	0017313

- a. The bidders not submitting EMD by due time & date shall be rejected & their bids shall not be evaluated further.
- b. **The EMD amount shall be 1.0 (One) Lakh INR**
- c. Firms registered with National Small-Scale Industries (NSIC)/MSME of India are exempted from submission of EMD/bid security. Central Public Sector Enterprises of India and Firms registered with Nation Small Scale Industries Corporation (NSIC) of India are exempted from submission of EMD/Bid Security. Central Public Sector Enterprises are requested to give a self-declaration on their letter head to this effect. Bidders registered with NSIC of India are also requested to submit self-declaration on their letter head to this effect along with a copy of their Valid Registration certificate.



DELHI AVIATION FUEL FACILITY PRIVATE LIMITED

16. **Delivery Period:** Time is the essence of the contract. The total order quantity (06 Nos) of EXPANSION JOINT (TIED DOUBLE METAL BELLOW EXPANSION JOINT) should be delivered within **02 (TWO) months** from the date of Letter of Intent/notification of award. Delivery period shall be counted from the date of notification of award (Letter/Fax/e-mail of Intent) up to the date of receipts of EXPANSION JOINT (TIED DOUBLE METAL BELLOW EXPANSION JOINT) along with all accessories at DAFFPL Fuel Farm, New Delhi.

17. The contractual delivery period of 02 months is inclusive of all the lead time for procurement of raw materials, the manufacturing, inspection / testing, packing or any other activity whatsoever required to be accomplished for effecting the delivery at the required delivery point.

THE FORMS /ATTACHMENTS TO THIS TENDER ARE AS UNDER:

1. Covering Note – CHAPTER: 1
2. Instructions To Bidders - CHAPTER: 2
3. Bid-Qualification Criteria - CHAPTER: 3
4. Performance of Work – CHAPTER: 4
5. Scope of Work- CHAPTER: 5
6. General Purchase Conditions- CHAPTER: 6
7. Technical Specifications/Material Requisition Documents - (Attached as Annexure I)
8. Annexure attached are as follows:
 - Annexure II – DEVIATION SHEET
 - Annexure III – DECLARATION SHEET
 - Annexure IV – FORMAT FOR DRAFT BANK GUARANTEE IN LIEU OF BID SECURITY (EMD)
 - Annexure V - FORMAT DRAFT COMPOSITE BANK GUARANTEE FOR SECURITY DEPOSIT/PERFORMANCE GUARANTEE
 - Annexure VI – FORM OF LETTER OF UNDERTAKING
 - Annexure VII – DECLARATION TO BE SUBMITTED ALONGWITH Technical BID
 - Price Bid

Thanking you,
Yours faithfully,
For DELHI AVIATION FUEL FACILITY (P) LTD.
Chief Executive Officer



CHAPTER 2: INSTRUCTIONS TO BIDDERS

1. The bidder shall bear all costs associated with the preparation and submission of the bid and Owner will in no case be responsible or liable for these costs, regardless of the conduct or outcome of the bidding process.
2. The bidders should have valid class 3 Digital sign certificate with encryption.
3. Bidders are requested to register on our E-Tendering portal on <https://daffpl.enivida.com>
4. Bidder can contact on e-portal helpdesk numbers 011-49606060, 9355030617 during 9:30 hrs to 18:00 hrs for any query/assistance for registration & tender documents submission.
5. Vendor is requested to submit their bids taking full notice of all the technical specifications, terms and conditions, forms & attachments to this tender. Bids must be submitted only through e-Tender portal.
6. Owner reserves the right to accept / reject any or all bid qualification documents at their sole discretion without assigning any reason whatsoever.
7. Owner is not responsible for any delays from bidder end.
8. Owner reserves the right to make any changes in terms and conditions of purchase before due date of bid submission and to reject any or all bids received incomplete.
9. Undertaking by the bidder:
 - a. I/we hereby undertake that the statements made herein/information given in the bids through e-Tendering system/annexure/forms referred are true in all respects and that in the event of any such statement or information being found to be incorrect in any particular, the same may be construed to be a misrepresentation entitling DAFFPL to avoid any resultant contract.
 - b. I/we further undertake as and when called upon by DAFFPL to produce, for its inspection, original(s) of the document(s) of which copies have been annexed hereto.



DELHI AVIATION FUEL FACILITY PRIVATE LIMITED

10. Owner, at its discretion reserves the right to verify information submitted by the bidders.
11. Bidder to submit documents/information to satisfy the bid qualification criteria. Bidders should also be able to produce further information as and when required by DAFFPL with in a time limit as specified by DAFFPL.
12. DAFFPL reserves their right to negotiate the quoted prices with lowest bidder.
13. Bidders would be qualified based on data and documents submitted by them.
14. Owner's decision on any matter regarding short listing of vendors shall be final and no corresponding in this regard will be entertained.
15. The vendors who are on IOCL/BPCL/DIAL holiday list or delisted will not be considered.
16. The bidder is expected to examine all instructions, forms, attachments, terms and specifications in the tender document. The entire tender document together with all its attachments thereto, shall be considered to be read, understood and accepted by the bidder, unless deviations are specifically stated seriatim by the bidder. Failure to furnish all information required in the tender document or submission of a bid not substantially responsive to the tender documents in every respect will be at bidder risk and may result in the rejection of his bid. The bidder scope of supplies as specified in the material requisition shall be in strict compliance with the scope detailed therein and in the bid document.
17. Bidders in their own interest shall ensure that they submit their bid, complete in all respects, well within the specified bid due date and time. No relaxation shall be given for delay due to any unforeseen event in submission of bid.
18. At any time prior to the bid due date, we may, for any reason, whether at its own initiative or in response to a clarification requested by a prospective bidder, modify the bid document. The amendment will be notified through our portal for e-tender to all prospective bidders and will be binding on them. In order to afford prospective bidder, reasonable time in which to take the amendment into account in preparing their



DELHI AVIATION FUEL FACILITY PRIVATE LIMITED

bids, we may, at our discretion, extend the bid due date.

19. The bid prepared by the bidder and all correspondence/ drawings and documents relating to the bid exchanged by bidder and the owner shall be written in ENGLISH language, provided that any printed literature furnished by the bidder may be written in another language so long as accompanied by an ENGLISH translation, in which case, for the purpose of interpretation of the bid, the ENGLISH translation shall govern.
20. Declaration with the bid qualification criteria that bidder has not been banned or delisted by any Government or quasi Government agencies or Public Sector Undertaking (PSU) as per declaration format (provided as annexure) of the tender document should be submitted along with the bid.
21. Bidders are advised to submit bids based strictly on the terms & conditions and specifications contained in the tender document and not to stipulate any deviations. Each Bidder shall submit only one bid. A Bidder who submits more than one bid will be rejected. Alternative bids will not be accepted.
22. The Owner may, at its discretion, extend the bid due date, in which case all rights and obligations of the Owner and the Bidders, previously subject to the bid due date, shall thereafter be subject to the new bid due date as extended. The same will be hosted in the e-tendering portal.
23. Bids shall be kept valid for 4 months from the bid due date. A bid valid for a shorter period shall be considered as non-responsive and rejected by the Owner. Notwithstanding above, the Owner may solicit the Bidder consent to an extension of the period of bid validity. The request and the responses thereto shall be made in writing. The EMD (bid security) shall also be accordingly extended.
24. Telex/ Telegraphic/ Telefax / E-mail/Physical offers will not be considered and shall be rejected.
25. No bid shall be modified subsequent to the due date & time or extension, if any, for submission of bids. Bidder(s) to note that Price changes after submission of bid shall not be allowed. In case any bidder gives revised prices/price implication, his bid shall be rejected. No bid shall be allowed to be withdrawn in the interval between the deadline for submission of bids and the expiration of the period of bid validity specified by the



DELHI AVIATION FUEL FACILITY PRIVATE LIMITED

Bidder. Withdrawal of a bid during this interval shall result in the forfeiture of Bidder's EMD.

26. Bids that do not meet the Bid qualification criteria as specified in the bid document shall be rejected. A bid with incomplete scope of work and/or which does not meet the technical requirements as specified in the bid document, shall be considered as non-responsive and rejected. Conditional bids will be liable for rejection.
27. The Owner will examine the bids to determine whether they are complete, whether any computational errors have been made, whether the documents have been properly signed and whether the bids are generally in order.
28. The bids without requisite EMD and/or not in the prescribed Performa and the time limit will not be considered and bids of such bidder(s) shall be rejected.
29. PRICE EVALUATION CRITERIA: As award is on overall landed lowest basis, part offers will be rejected. Bidder has to quote for all items in a lot for us to consider them.
30. Prior to the expiration of period of bid validity, the owner will notify the successful bidder in writing or by e-mail, that his bid has been accepted. The Notification of Award will constitute the formation of the Contract. Delivery Period shall be counted from the date of notification of award (Letter/Fax/e-mail of Intent).
31. Any efforts by a bidder to influence the owner/ in the owner bid evaluation, bid comparison or contract award decisions may result in the rejection of their bid.
32. ISSUE OF CONTRACT/ PURCHASE ORDER: After the successful bidder has been notified that his bid has been accepted, DAFFPL will send to such bidder a detailed contract/purchase order incorporating all the terms and conditions agreed between the parties. Within 15 days of receipt of the detailed purchase order, the bidder shall sign and return to the owner the duplicate copy of the order as a token of their acknowledgement.
33. Vigil Mechanism: DAFFPL has developed the Vigil Mechanism to deal with references/ grievances, if any, that is received from bidders who



DELHI AVIATION FUEL FACILITY PRIVATE LIMITED

participated / intends to participate in the tender. The details of the same are available on our website www.daffpl.in

34. VERIFICATION BY OWNER: All statements submitted by bidder regarding experience, manpower availability, equipment and machinery availability etc., are subject to verification by the owner either before placement of order or after placement of order. If any data submitted by the bidder at the bid stage is found to be incorrect, the offer is liable to be rejected or the contract/order is liable to be terminated.

35. EVALUATION OF BIDS

- a. Qualification of Bidder: The experience details and financial & technical capabilities of the bidder(s) shall be examined to determine whether the bidder(s) meet the Bid Qualification Criteria mentioned in the INVITATION FOR BIDS (IFB).
- b. The Owner will examine the bids to determine whether they are complete & if they are free of any computational errors, whether the documents have been properly signed and whether the bids are generally in order.
- c. The bids without requisite Bid Security and/or not in the prescribed proforma will not be considered and bids of such bidder Bidder(s) shall be rejected.
- d. To assist in the examination, evaluation and comparison of technical bids, the owner/ may, at its discretion, ask the Bidder clarifications on the bid. The request for such clarifications and the response thereto shall be through the e-tendering portal.
- e. Prior to the evaluation and comparison of the bid, the owner will determine the substantial responsiveness of each bid to the bidding documents. For the purpose of this Article, a substantially responsive bid is one, which conforms to all the terms and conditions of the bidding document without material deviations or reservations. A material deviation or reservation is one which affects in any substantial way the scope, quality, or performance of the works or which limits in any substantial way, inconsistent with the bidding document, the DAFFPL's rights or Bidder's obligation under the contract and retention of which deviation or reservation would affect unfairly the competitive position of other bidders presenting substantially responsive bids. The owner's determination of bid responsiveness is to be based on the contents of the bid itself without recourse to the extrinsic evidence.



DELHI AVIATION FUEL FACILITY PRIVATE LIMITED

- f. A bid determined as substantially non-responsive after final evaluation will be rejected by the Owner and shall not subsequently be allowed by the Owner to be made responsive by the Bidder by correction of the non-conformity.

Note:

- 1) **The Bid Shall be submitted in English Language Only**
- 2) **For any Document submitted in any language other than English, the translation copy in English language shall be submitted.**

CHAPTER 3: BID-QUALIFICATION CRITERIA

Bidders need to meet following pre-qualification criteria to qualify for short-listing as a successful vendor for this tender;

➤ **Technical Criteria:**

The bidder shall have satisfactorily executed either of the following during the last 7 years ending 31/03/2022:

The Bidder should have completed at least **one similar work**, costing not less than **INR 12 Lakhs**.

OR

The Bidder should have completed at least **two similar works**, each costing not less than **INR 7.5 Lakhs**.

OR

The Bidder should have completed at least **three similar works**, each costing not less than **INR 6 Lakhs**.

Notes:

- a. Similar works means supply of expansion bellows.

FINANCIAL CAPACITY

Bidder shall have minimum average annual turnover of **Rs. 25.00 Lakhs** as per audited financial results in the preceding three financial/calendar years. "Turnover shall mean Consolidated Turnover in case of a Bidder having wholly owned subsidiaries"



DELHI AVIATION FUEL FACILITY PRIVATE LIMITED

Note: Turnover for this purpose should be as per audited P&L statement including Balance Sheet/ Published Account/ Profit & Loss Account Statement of the tenderer. However, if the tenderer is not required to get its accounts audited under Section 44AB of the Income Tax Act, 1961, (Applicable for FY21-22 as well, in case financial statement of bidder has not been audited at the time of submission of bids) certificate from a practicing Chartered Accountant towards the turnover of the tenderer along with copies of its income tax return should be obtained.

Total revenue as per schedule III of companies' act, 2013 (earlier revised schedule VI of companies Act, 1956) shall be considered as Turnover. Audited balance sheet / published accounts on calendar year basis shall also be acceptable. The financial statements copy must bear the registration number of the authorised chartered accountant and its seal. (This is not applicable for published annual reports).

- Both the above criteria (Technical & Financial) to be met for acceptance of the bid.

OTHER INFORMATION OF BQC

1. Parties who are affiliates of one another can decide which affiliate will make a bid. Only one affiliate may submit a bid. Two or more affiliates are not permitted to make separate bids directly or indirectly. If 2 or more affiliates submit a bid, then any one or all of them are liable for disqualification. However up to 3 affiliates may make a joint bid as a consortium, and in which case the conditions applicable to a consortium shall apply to them. "Affiliate" of a Party shall mean any company or legal entity which:
 - a. Controls either directly or indirectly a Party, or
 - b. Which is controlled directly or indirectly by a Party; or
 - c. Is directly or indirectly controlled by a company, legal entity or Partnership which directly or indirectly controls a Party. "Control" means actual control or ownership of at least a 50% voting or other controlling interest that gives the power to direct, or cause the direction of, the management and material business decisions of the controlled entity.
2. Bids may be submitted by:
 - a. A single person/ entity (called sole bidder):
 - b. A newly formed incorporated joint venture (JV) which has not completed 3 financial years from the date of commencement of business;



DELHI AVIATION FUEL FACILITY PRIVATE LIMITED

- c. A consortium (including an unincorporated JV) having a maximum of 3 (three) members;
 - d. An Indian arm of a foreign company.
3. Fulfillment of Eligibility criteria and certain additional conditions in respect of each of the above 4 types of bidders are stated below, respectively:
- a. The sole bidder (including an incorporated JV which has completed 3 financial years after date of commencement of business) shall fulfill each eligibility criteria.
 - b. In case the bidder is a newly formed and incorporated joint venture and which has not completed three financial years from the date of commencement of business, then either the said JV shall fulfill each eligibility criteria or any one constituent member/promoter of such a JV shall fulfill each eligibility criteria. If the bid is received with the proposal that one constituent member/promoter fulfils each eligibility criteria, then this member/promoter shall be clearly identified and he/it shall assume all obligations under the contract and provide such comfort letter/guarantees as may be required by Owner. The guarantees shall cover inter alia the commitment of the member/ promoter to complete the entire work in all respects and in a timely fashion, being bound by all the obligations under the contract, an undertaking to provide all necessary technical and financial support to the JV to ensure completion of the contract when awarded, an undertaking not to withdraw from the JV till completion of the work, etc.
 - c. In case the bidder(s) is/are a consortium (including an unincorporated JV), then the following conditions shall apply:
 - I. Each member in a consortium may only be a legal entity and not an individual person;
 - II. The Bid shall specifically identify and describe each member of the consortium;
 - III. the consortium member descriptions shall indicate what type of legal entity the member is and its jurisdiction of incorporation (or of establishment as a legal entity other than as a corporation) and provide evidence by a copy of the articles of incorporation (or equivalent documents);
 - IV. One participant member of the consortium shall be identified as the "Prime member" and contracting entity for the consortium;
 - V. This prime member shall be solely responsible for all aspects of the Bid/ Proposal including the execution of all tasks and performance of all consortium obligations;
 - VI. The prime member shall fulfill each eligibility criteria;



DELHI AVIATION FUEL FACILITY PRIVATE LIMITED

- VII. a commitment shall be given from each of the consortium members in the form of a letter signed by a duly authorized officer clearly identifying the role of the member in the Bid and the member's commitment to perform all relevant tasks and obligations in support of the
 - VIII. Prime/lead member of the Consortium and a commitment not to withdraw from the consortium;
 - IX. No change shall be permitted in the number, nature or share holding pattern of the Consortium members after pre-qualification, without the prior written permission of the Owner.
 - X. No change in project plans, timetables or pricing will be permitted as a consequence of any withdrawal or failure to perform by a consortium member;
 - XI. Entities which are affiliates of one another are allowed to bid either as a sole bidder or as a consortium only;
 - XII. Any person or entity can bid either singly or as a member of only one consortium.
- d. In case the bidder is an Indian arm (subsidiary, authorized agent, branch office or affiliate) of a foreign bidder, then the foreign bidder shall have to full fill each eligibility criteria. If such foreign company desires that the contract be entered into with the Indian arm, then a proper back to back continuing (parent company) guarantee shall be provided by the foreign company clearly stating that in case of any failure of any supply or performance of the equipment, machinery, material or plant or completion of the work in all respects and as per the warranties/ guarantees that may have been given, then the foreign company shall assume all obligations under the contract. Towards this purpose, it shall provide such comfort letter/guarantees as may be required by Owner. The guarantees shall cover inter alia the commitment of the foreign company to complete the entire work in all respects and in a timely fashion, being bound by all the obligations under the contract, an undertaking to provide all necessary technical and financial support to the Indian arm or to render the same themselves so as to ensure completion of the contract when awarded, an undertaking not to withdraw from the contract till completion of the work, etc.



CHAPTER 4: PERFORMANCE OF WORK

1. EXECUTION OF WORKS:

- a. All the works shall be executed in strict conformity with the provisions of the contract documents and with such explanatory detailed drawings, specifications, and instructions as may be. The contractor shall be responsible for ensuring that works throughout are executed in the most substantial, proper and workman like manner with the quality of material and workmanship in strict accordance with the specifications following all safety requirements and to the entire satisfaction of the DAFFPL.
- b. Wherever it is mentioned in the specifications that the Contractor shall perform certain work or provide certain facilities/materials, it is understood that the contractor shall do, so at his cost unless otherwise specified.
- c. The materials, design and workmanship shall satisfy the relevant Indian Standards, the Job specification contained herein and codes referred to. Where the job specification stipulate requirements in addition to those contained in the standards codes and specifications, these additional requirements shall also be satisfied.

2. MATERIALS TO BE SUPPLIED BY CONTRACTOR:

- a. The contractor shall procure and provide the whole of the materials required to complete the job including tools, tackles and equipment etc. The materials procured by the contractor shall be DAFFPL approved/specified quality.
- b. All materials procured/used should meet the specifications given in the tender document. The Engineer-in-Charge may, at his discretion, ask for samples and test certificates for any batch of any material. Before procuring, the contractor should get the approval of Engineer-in-Charge for any material to be used for the works.
- c. Manufacturer's certificate shall be submitted for all materials supplied by the contractor. If, however, in the opinion of the Engineer-in-Charge any tests are required to be conducted on the materials supplied by the contractor, these will be arranged by the contractor promptly at his own cost.

3. INSPECTION OF WORK:

- a. The Engineer-in-Charge will have full power and authority to inspect the works at any time wherever in progress either on the Site or at the contractor's premises / workshop where situated premises



DELHI AVIATION FUEL FACILITY PRIVATE LIMITED

/workshops of any person, firm or corporation where work in connect with the contract may be in hand or where materials are being or are to be supplied, and the contractor shall afford or procure for the Engineer-in-Charge every facility and assistance to carry out such Inspection. The contractor shall at all times during the usual working hours and at all other time for which reasonable notice of the intention of the Engineer in-Charge or his representative to visit the works have been given to the contractor, either himself be present to receive order and instructions or post a responsible agent duly accredited in writing for the purpose. Orders given to the contractor's agent shall be considered to have the same force as if they had been given to the contractor himself. The contractor shall give not less than seven days, notice in writing to the Engineer-in-Charge before covering up or placing any work beyond reach of inspection and measurement any work in order that the same may be inspected and measured. In the event of breach of above the same shall be uncovered at contractor's expense carrying out such measurement or inspection.

b. No materials shall be dispatched by the contractor before obtaining the approval of Engineer-in-Charge in writing.

4. ASSISTANCE TO THE ENGINEERS:

The contractor shall make available to the Engineer-in-Charge, free of cost necessary instruments and assistance in checking of setting out of works/inspection.

5. TESTS FOR QUALITY OF WORKS:

a. All workmanship shall be of the respective kinds described in the contract documents and in accordance with the instructions of the Engineer-in-Charge and shall be subjected from time to time to such test at contractor's cost as the Engineer-in-Charge may direct at place of manufacture or fabrication or on the site or at all or any such places. The contractor shall provide assistance, instruments, labour and materials as are normally required for examining, measuring and testing any workmanship as may be selected and required the Engineer-in-Charge.

6. ACTION AND COMPENSATION IN CASE OF BAD WORK:

If it shall appear to the Engineer-in-Charge that any work has been executed with unsound, imperfect or unskilled workmanship or with materials of any inferior description, or that any materials or articles



provided by the contractor for the execution of the work are unsound or of a quality inferior to that contracted for, or otherwise not in accordance with the contract, the contractor shall on demand in writing from the Engineer-in-Charge or his authorized representative, specifying the work, materials or articles complained of, notwithstanding that the same have been inadvertently passed, certified and paid for forthwith shall rectify or remove and reconstruct the works specified and provide other proper and suitable materials or articles at his own charge and cost, and in the event of failure to do so within a period to be specified by the Engineer-in-Charge in his demand aforesaid, the contractor shall be liable to pay compensation at the rate of 0.5% of the estimated cost of the whole work, for every week limited to a maximum of 10% of the estimated cost of the whole work, while his failure to do so shall continue and in the case of any such failure the Engineer-in-Charge may on expiry of notice period rectify or remove and re-execute the work or remove and replace with others, the materials or articles complained of as the case may be at the risk and expenses of the contractors in all respects. The decision of the Engineer-in-Charge as to any question arising under this clause shall be final and conclusive.

7. SUSPENSION OF WORKS:

The contractor shall, if ordered in writing by the Engineer-in-Charge or his representative, temporarily suspend the works or any part thereof for such period and such time as so ordered and shall not, after receiving such written order, proceed with the work therein ordered to be suspended, until he shall have received a written order to proceed therewith. The contractor shall not be entitled to claim/ compensation for any loss or damage sustained by him by reason of temporary suspension of the works aforesaid. An extension of time for completion, corresponding with the delay caused by any such suspension of the works as aforesaid will be granted to the contractor, should he apply for the same, provided that suspension was not consequent to any default or failure on the part of the contractor.

8. OWNER MAY DO PART OF WORK:

Upon failure of the contractor to comply with any instructions given in accordance with the provisions of the contract, the owner has the alternative right, instead of assuming charge for entire work to place additional labour force, tools, equipments and materials on such parts of the work, as the owner may designate or also engage another contractor to carry out the work. In such cases, the owner shall deduct from the



DELHI AVIATION FUEL FACILITY PRIVATE LIMITED

amount which otherwise might become due to the contractor, the cost of such work and materials with ten percent added to cover all departmental charges and should the total amount thereof exceed the amount due to the contractor, the contractor shall pay the difference to the owner.

9. PERIOD OF LIABILITY FROM THE DATE OF COMPLETION OF WORK:

- a) Materials shall be guaranteed against manufacturing defects, materials, workmanship, and design for a period of 12 months from the date of commissioning or 18 months from the date of delivery whichever is later. Warranty for replacement of material / accessories should be provided free of charges at our premises. The above guarantee/warranty will be without prejudice to the certificate of inspection or material receipt note issued by us in respect of the materials.
- b) All the materials including components and subcontracted items should be guaranteed by the vendor within the warranty period mentioned above. In the event of any defect in the material, the vendor will replace / repair the material at DAFFPL concerned location at vendor risk and cost on due notice.
- c) Alternatively, DAFFPL reserves the right to have the material repaired / replaced at the locations concerned, at the vendor s risk, cost and responsibility, in case, vendor does not replace / repair the material.
- d) The Vendor shall provide similar warrantee on the parts, components, fittings, accessories etc. so repaired and / or replaced.
- e) RISK PURCHASE CLAUSE: We reserve the right to curtail or cancel the order either in full or part thereof if you fail to comply with delivery schedule and other terms & conditions of the order. DAFFPL also reserves the right to procure same or similar materials/equipment through other sources at vendor s entire risk, cost and consequences.
- f) Any damage that may lie undiscovered at the time of issue of completion certificate, connected in any way with the equipment or materials supplied by him or in the workmanship shall be rectified or replaced by the contractor at his own expense as deemed necessary by the Engineer-in-Charge or in default, the Engineer-in-Charge may cause the same made good by other workmen and deduct expenses (for which the certificate of Engineer-in-Charge shall be final) from any sums that may be then or at any time thereafter, become due to the contractor or from his security



DELHI AVIATION FUEL FACILITY PRIVATE LIMITED

deposit. Effects prior to taking over: If at any time, before the work is taken over, the Engineer-in-Charge shall

- Decide that any work done, or materials used by the contractor, or any sub-contractor is defective or not in accordance with the contract or that the works or any portion thereof are defective or do not fulfill the requirements of contract (all such matters being herein after called 'Defects' in this clause) and
- As soon as reasonably practicable, notice given to the contractor in writing of the said decisions specifying particulars of the defects alleged to exist or to have occurred, then the contractor shall at his own expenses and with all speed make good the defects so specified. In the case contractor shall fail to do so, the Owner may take, at the cost of the contractor, such steps as may in all circumstances, be reasonable to make good such defects. The expenditure, so incurred by the Owner shall be recovered from the amount due to the contractor. The decision of the Engineer-in-Charge with regard to the amount be recovered from the contractor will be final and binding on the contractor. As soon as the works have been completed in accordance with the contract and have passed the tests on completion, the Engineer-in-Charge shall issue a certificate (hereinafter called completion certificate) in which he shall certify the date on which the work have been so completed and have passed the said tests and the Owner shall be deemed to have taken over the works on the date so certified. If the works have been divided into various groups in the contract, the Owner shall be entitled to take over any group or groups before the other or others and thereupon the Engineer-in-Charge shall issue a completion certificate which will however, be for such group or groups as taken over only.

- g) Defects after taking over: In order that the contractor could obtain a completion certificate, he shall make good with all possible speed, any defect arising from the defective materials supplied by the Contractor or workmanship or any act of omission of the contract that may have been noticed or developed after the works or group of the works has been taken over. The period allowed for carrying out such work will be normally one month. If any defect be not remedied within a reasonable time, the Owner may proceed to do the work at the contractor's risk and expense and deduct from the final bill such amount as may be decided by the Owner. If by



DELHI AVIATION FUEL FACILITY PRIVATE LIMITED

reason of any default on the part of the contractor a completion certificate has not been issued in respect of every portion of the work within one month after the date fixed by the contract for the completion of the works, the Owner shall be at his liberty to use the works or any portion thereof in respect of which a completion certificate has been issued provided that the works or the portion thereof so used as aforesaid shall be afforded reasonable opportunity for completing these works for the issue of completion certificate.

- h) The Security Deposit/retention money deducted / furnished shall be retained for the period of liability as given in clause above. This Retention amount or Bank Guarantee furnished against Security Deposit/retention money shall be released only on expiry of the period of liability and also based on the certification of the Engineer-in-charge that no defect/damage has been reported / observed during the stipulated period of liability for the contract.

CHAPTER 5: SCOPE OF WORK

- a) Scope includes supply of EXPANSION JOINT (TIED DOUBLE METAL BELLOW EXPANSION JOINT) with all required accessories, hard copies as well as soft copies of applicable drawings/documents etc. for door delivery basis at DAFFPL Fuel Farm in New Delhi.
- b) Item shall be packed in suitable weather proof packaging.
- c) These shall be suitable for continuous use in Liquid hydrocarbon product, viz. Jet fuel.
- d) The offer/quoted amount should also include all other elements like Custom Duties (if any), Insurance charges, approval charges, testing charges, transportation, and unloading at site for door delivered price of equipment at DAFFPL Fuel Farm, New Delhi in India.
- e) The third-party inspection charges shall be borne by DAFFPL.

CHAPTER 6: GENERAL TERMS & CONDITIONS

1. General:

The materials and workmanship shall satisfy the relevant Indian Standards, the job specifications contained herein & codes referred to. Where the job specifications stipulate requirements in addition to those contained in the standard codes and specifications, these additional



DELHI AVIATION FUEL FACILITY PRIVATE LIMITED

requirements shall also be satisfied.

In the absence of any standard / specification / codes of practice for detailed specifications covering any part of the work covered in this tender document, the instruction / direction of consultant engineer will be binding on the contractor.

Wherever it is stated in this tender document that a particular supply is to be affected or that a particular work is to be carried out, it shall be understood that the same shall be affected / carried out by the contractor at his cost, unless a different intention is specifically and expressly stated herein or otherwise explicit from the context.

2. DAFFPL reserves the right to accept any tender in whole and reject any or all tenders without assigning any reason. DAFFPL also reserves the right to allow public enterprises (Central/State) Price / purchase /contract / service preference as admissible under the Indian Government Policy.
3. **BID PRICES:**
 - a) Prices shall be furnished strictly in the Price Bid format of the tender document.
 - b) Bidder should quote their lowest and best offered price. Prices so quoted will remain firm till satisfactory completion of order. The price will not be subjected to escalation for any reason whatsoever.
 - c) Bidders quoted prices shall be deemed to include entire Specification of item and all obligations and responsibilities to be carried out / executed by the Bidder as per terms of tender document. It is clearly understood by the Vendor that it is for the Vendor to ascertain and assess the applicable Acts/ Regulations/ Laws etc., entirely of their own. It is also for the Vendor to ascertain and assess the applicability of taxes, duties, levies etc. In case of any difference of opinion between Vendor's proposal and interpretation by any tax/assessing (or similar) authorities, on the rate or terms and conditions related to taxes and duties etc., owner's liability shall be strictly as per terms/provisions of the contract based on tender document and Vendors offer.
 - d) No other charges accept those mentioned in the tender document will be payable to vendor.
 - e) The Vendor/Bidder shall also provide list of spares for 02 (Two) years of operations post Warranty Period. Unit rates of the spares, which shall be valid for a period of 36 months from the date of order, shall



DELHI AVIATION FUEL FACILITY PRIVATE LIMITED

be provided along with price bid as a separate annexure. However, the owner reserves the right for negotiations & procurement of these spares as & when required from the successful bidder for EXPANSION JOINT (TIED DOUBLE METAL BELLOW EXPANSION JOINT).

4. Materials are required to be dispatched by the vendor to the locations, on freight paid DOOR- DELIVERY CONSIGNEE COPY ATTACHED basis along with copies of Inspection release note & internal test certificates & other documents as mentioned elsewhere in this tender document. Unloading of packaged material is in scope of bidder.
5. Bidder shall quote considering the cost of all approvals, insurances and other applicable charges; nothing shall be paid/reimbursed additionally on any account.
6. Goods & Services Tax (GST): -The tenderer should have valid Goods & Service Tax registration. Tenderer should enclose the copy of the registration (GST) /copy of acknowledgement along with the tender. The Parties without valid Goods & Service Tax number need not quote. As per Section 171 of CGST/SGST Act, "Any reduction in rate of tax on any supply of goods or services or the benefit of input tax credit shall be passed on to the recipient by way of commensurate reduction in prices.
7. TAXES & DUTIES:
 - a) Bidder(s) quoted prices shall be exclusive of all taxes, duties, cess, levies etc.,
 - b) The invoice should clearly mention that applicable Excise Duty, Education Cess or any other taxes charged and paid / payable on quoted item to enable the owner to claim MODVAT / Input credit.
 - c) The statutory variation in Excise duty, Education Cess and Sales tax / VAT/GST on finished goods and introduction of new tax, from bid due date till the contractual completion period shall be to owner account against submission of the documentary evidence. However, any increase in the rate of these taxes and duties beyond the contractual delivery period shall be to Seller account. Any decrease in the rate of these taxes and duties shall be passed on to the owner. Any additional excise duty due to increase in turn-over would be to seller account.
 - d) It is for the Bidder to assess and ascertain the rate of excise duty, education Cess and sales tax/VAT applicable on quoted items. It is



DELHI AVIATION FUEL FACILITY PRIVATE LIMITED

clearly understood that Owner will not have any additional liability towards payment of Excise Duty, Education Cess, GST and Sales Tax/VAT which is based on Bidders wrong assessment / interpretation of applicability of such Excise Duty and/or education cess and / or Sales Tax/VAT.

- e) Successful bidder shall carry out its obligations towards services at site as mentioned in technical specifications without any extra charges.
- f) Octroi/Entry tax, if any, in the any state of India shall be directly paid by the vendor, if applicable.
- g) DAFFPL shall not be liable, in case the tax authorities assess the tax elements in a different way on account of any reason, whatsoever.
- h) Taxes and duties other than those specified in this document, if any, shall be included in the quoted prices and no separate reimbursement shall be made by DAFFPL.

8. Income Tax / Corporate Tax:

- a) As regards Income Tax, Surcharge on Income Tax or any other Corporate Tax payable by the Bidder for reason of the contract awarded, and / or on their expatriate personal, the Owner shall not bear any Tax liability whatsoever, irrespective of the mode of construction of contract / order. The Bidder shall be liable and responsible for payment of such tax, if attracted under the provision of Indian Income Tax Act.
- b) Bidder may note that if any tax is deductible at source as per Indian Income Tax Law, the same will be so deducted before releasing any payment to the Bidder and a TDS (Tax deducted at source) certificate will be furnished to the Bidder.
- c) Bidder may note that where the responsibility to deduct TDS under section 194Q of Income Tax Act is on DAFFPL, bidder shall not collect any TCS under section 206C(1H) of the Income Tax Act from DAFFPL.**
- d) Accordingly, Bidder shall have the responsibility to check and include such provision of taxes in the prices.
- e) In case of delay in delivery due to reasons attributable to Bidder, any new or additional taxes or duties levied by Statutory authorities during this period shall be borne by the Bidder.

9. EMD / BID SECURITY

- a) The bidder shall furnish, as part of his bid, a bid security in original for the amount specified in the tender document by way of pay order, bank guarantee on Rs.100/-value non-judicial stamp paper or



DELHI AVIATION FUEL FACILITY PRIVATE LIMITED

demand draft.

- b) The bid security is required to protect the Owner against the risk of Bidders conduct, which would warrant the security forfeiture.
- c) If bid Security / EMD is in the form of bank guarantee, it shall be in the form of irrevocable bank guarantee (in the format attached) issued by any Indian Scheduled Bank (other than Co-operative Bank) will be accepted.
- d) Bid Security / EMD shall be issued in favour of M/s Delhi Aviation Fuel Facility (P) Limited, New Delhi.
- e) Unsuccessful bidders bid security without any interest will be discharged/ returned as promptly as possible, but not later than 60 days after the expiry of the period of bid validity prescribed by the Owner.
- f) The successful bidder bid security without any interest will be discharged, upon the Bidder accepting the Contract/ Purchase Order and furnishing the Contract performance bank guarantee to DAFFPL.
- g) The bid security may be forfeited:
 - i. If a bidder withdraws his bid during the period of bid validity or
 - ii. In the case of a successful bidder, if the bidder fails or refuses to:
 - Accept the Purchase Order in accordance with agreed terms and conditions.
 - Furnish Contract performance bank guarantee as per bid document/ Purchase Order.
 - iii. Detection of submission of false / forged documents and fraud.
- h) Central Public Sector Undertaking of Govt. Of India are exempted from furnishing the bid security. Firms registered with NSIC/ MSME are also exempted from furnishing bid security, provided they are registered for the tendered items and up to the monetary limit they intend to quote. Provided further that they submit a copy of the current and valid registration certificate for the quoted item and monetary value along with their bid(s). Owner reserves right to verify the registration certificate provided, with relevant authorities.

10. CONTRACT PERFORMANCE BANK GUARANTEE [CPBG]

- a) As a Performance security, the successful Bidder, to whom the work is awarded by, shall be required to furnish within 30 days of notification of award of contract (Letter/ Fax/e-mail of Intent) a



DELHI AVIATION FUEL FACILITY PRIVATE LIMITED

Performance Bank Guarantee on RS.100/- VALUE non-judicial stamp paper in favour of the Owner (M/S DAFFPL).

- b) The Bank Guarantee amount shall be equal to TEN PERCENT (10%) of the Total Order Value, and it shall guarantee the faithful performance of the Order in accordance with the Terms and conditions specified in the documents and specifications.
- c) CPBG shall be in the form of an irrevocable Bank Guarantee (in the format attached) issued by any Indian Scheduled Bank (other than Co-operative Bank).
- d) The Bank Guarantee shall be valid for the entire period of the Contract, namely, till the end of the guarantee / warranty period. The guarantee amount shall be payable on demand to the Owner.
- e) In case, the Contract Performance Bank Guarantee stated above gets reduced/ deducted for reasons of non-fulfillment of any Contractual obligations upto the completion of guarantee period, the bidder shall immediately take action to increase the value of Bank Guarantee to TEN PERCENT (10%) of the Contract price, to cover his guarantee/warranty obligations.
- f) The Performance Guarantee will be returned to the bidder without any interest at the end of the warranty / guarantee period subject to fulfillment of all contractual obligations by the Bidder. The bank guarantee shall have a claim period of 06 months beyond the contractual guarantee period.
- g) The proceeds of performance security shall be appropriated by the owner as compensation for any loss resulting from vendor's failure to complete his obligations under the contract to the prejudice to any of the rights or remedies the owner may be entitled to as per terms and conditions of contract. The proceeds of this performance security shall also govern the successful performance of goods and services and vendors all obligations during the entire period of contractual warranty / guarantee.

11. PRICE REDUCTION FOR DELAY IN DELIVERY:

The delivery period quoted must be realistic & specific. The inability of successful bidder to execute orders in accordance with the agreed completion schedule will entitle DAFFPL, at its options, to:

- a) Accept delayed delivery at prices reduced by a sum equivalent to one percent (1%) of the total order value of material not delivered for every week of delay or part thereof which is to be considered as a week, limited to a maximum of 10% of the total order value. Date of delivery of material/equipments at DAFFPL site shall be



DELHI AVIATION FUEL FACILITY PRIVATE LIMITED

considered for calculation of price reduction.

- b) The price reduction will be applicable on ready to use EXPANSION JOINT (TIED DOUBLE METAL BELLOW EXPANSION JOINT) which is delivered after due date and total cost of material which is delivered after due date shall be considered for application of this clause.

12. Early Delivery: DAFFPL shall appreciate early delivery of the complete EXPANSION JOINT (TIED DOUBLE METAL BELLOW EXPANSION JOINT).

13. INSURANCE

Supplier shall carry and maintain any and all statutory insurance(s) required under Indian Laws and Regulations, including Workmen compensation Act/ESI/Third party liabilities etc. and insurances for their personnel engaged in performance of the work at their own cost.

The complete unit is to be fully insured by the Fabricator/Manufacturer/Supplier against loss, damage, and third party risks till the material/equipment is delivered to final destination.

TRANSIT & COMPREHENSIVE INSURANCE

The vendor shall arrange transit Insurance for door delivery of equipments to DAFFPL Fuel Farm, New Delhi for delivery.

14. INSPECTION:

- a) Material / construction/Fabrication shall be inspected by owner or its representative. Charges other than third party inspection, is entirely vendor responsibility and in no way should affect the completion schedule.
- b) OWNER may, at its own expense, witness any test or inspection. In order to enable OWNER to witness the tests/inspections OWNER will advise the bidder in advance whether it intends to be present at any of the inspections.
- c) Even if the inspection and tests are fully carried out, the Vendor shall not be absolved from its responsibilities to ensure that the Material(s), raw materials, components and other inputs are supplied strictly to conform and comply with all the requirements of the Contract at all stages, whether during manufacture and fabrication, or at the time of Delivery as on arrival at site and after its



DELHI AVIATION FUEL FACILITY PRIVATE LIMITED

commissioning or start up and during the defect liability period. The inspections and tests are merely intended to prima-facie satisfy OWNER that the Material(s) and the parts and components comply with the requirements of the Contract. The Vendor's responsibility shall also not be anywise reduced or discharged because OWNER or OWNER's representative(s) or Inspector(s) shall have examined, commented on the Vendor's drawings or specifications or shall have witnessed the tests or required any chemical or physical or other tests or shall have stamped or approved or certified any Material(s).

- d) Although material approved by the Inspector(s), if on testing and inspection after receipt of the Material(s) at the location, any Material(s) are found not to be in strict conformity with the contractual requirements or specifications, OWNER shall have the right to reject the same and hold the Vendor liable for non-performance of the Contract.

15. GUARANTEE/WARRANTY:

- i) Materials shall be guaranteed against manufacturing defects, materials, workmanship, and design for a period of 12 months from the date of delivery at DAFFPL site whichever is later. Warranty for replacement of material / accessories should be provided free of charges at our premises. The above guarantee/warranty will be without prejudice to the certificate of inspection or material receipt note issued by us in respect of the materials.
- j) All the materials including components and subcontracted items should be guaranteed by the vendor within the warranty period mentioned above. In the event of any defect in the material, the vendor will replace / repair the material at DAFFPL concerned location at vendor risk and cost on due notice.
- k) Alternatively, DAFFPL reserves the right to have the material repaired / replaced at the locations concerned, at the vendors risk, cost and responsibility, in case, vendor does not replace / repair the material.
- l) The Vendor shall provide similar warranty on the parts, components, fittings, accessories etc. so repaired and / or replaced.
- m) Vendor shall guarantee that the performance of the EQUIPMENT supplied under the CONTRACT shall be strictly in conformity with the specifications and shall perform the duties specified under the CONTRACT.
- n) RISK PURCHASE CLAUSE: We reserve the right to curtail or cancel the order either in full or part thereof if bidder fails to comply with delivery schedule and other terms & conditions of the order. DAFFPL



DELHI AVIATION FUEL FACILITY PRIVATE LIMITED

also reserves the right to procure same or similar materials/equipment through other sources at vendor's entire risk, cost and consequences.

16. AFTER SALES SERVICES:

Vendor should assume complete responsibility of satisfactory performance of the EXPANSION JOINT (TIED DOUBLE METAL BELLOW EXPANSION JOINT) and material used and the after sales service. During the period of warranty, the vendor shall provide free maintenance and service backup. All the complaints shall be attended to immediately within 72 hrs of reporting of a complaint.

17. TEST & PERFORMANCE CERTIFICATES: Bidder shall furnish Material test and Performance Certificates for the materials along with the challans and invoice.

18. PAYMENT TERMS: The payment will be made after making necessary deductions as applicable & stipulated elsewhere in the tender document for materials, security deposit or any moneys due to the Owner etc.

- Notwithstanding any other clause of the tender documents, payment for Goods and Service Tax amount claimed in the invoice for work done by the successful bidder will be released only after the invoice is reflected in GSTR-2A of DAFFPL/Owner
- Advance Payment is not permissible in this contract.
Submission of PBG equal to 10% of Total Order Value with in 30 days of issue of LOI/PO is compulsory.

The following payment terms shall be applicable:

- 80% will be released within 30 days from after the receipt and acceptance of material at site adjusting deductible if any and balance 20% after Installation, testing & commissioning of EXPANSION JOINT (TIED DOUBLE METAL BELLOW EXPANSION JOINT) on prorata basis.

Arrangement for Transit e-way Bill under the GST Act for all the purchases is the responsibility of the tenderer.



DELHI AVIATION FUEL FACILITY PRIVATE LIMITED

19. Only in the event of causes of Force Majeure occurring within the contractual delivery period and if they impede the performance of contract, the delivery dates shall be extended on receipt of application from the bidder / Owner without imposition of penalty. Only those causes which depend on natural calamities, civil wars, fire and national strikes which have duration of more than seven consecutive calendar days are considered the causes of force Majeure. The decision of Owner shall be final and binding on vendor.
20. The Vendor must advise the Owner by a registered letter duly certified by Local Chamber of Commerce or statutory authorities and Owner must advise the Vendor by a letter, the beginning and the end of the delay immediately, but in no case later than within 10 days of the beginning and end of such causes of Force Majeure condition as defined above. Provided further that if the performance in whole or part of any obligation under this contract is prevented or delayed by reason of any such event for period exceeding 60 days either party may at its option terminate the contract.
21. Repeat Order: DAFFPL reserves the right to place repeat order up to the order quantity within One Year from the date of original order on mutual agreement basis.
22. Any reference to the Govt. Acts /Regulations etc. in the Bid Document is only indicative, and it is entirely for the bidder to ascertain the applicable Acts/Regulations.
23. RECOVERY OF SUMS DUE: Whenever, any claim against bidder for payment of a sum of money arises out of or under the contract or in any other form, the owner shall be entitled to recover such sums from any sum then due or when at any time thereafter may become due from the vendor under this or any other form and should this sum be not sufficient to cover the recoverable amount of claim(s), the vendor shall pay to DAFFPL on demand the balance remaining due.
24. PATENTS & ROYALTIES: The vendor shall fully indemnify owner and users of materials specified herein/supplied at all times, against any action, claim or demand, costs and expenses, arising from or incurred by reasons of any infringement or alleged infringement of any patent, registered design, trademark or name, copy right or any other protected rights in respect of any materials supplied or any arrangement, system or method of using,



DELHI AVIATION FUEL FACILITY PRIVATE LIMITED

fixing or working used by the vendor. In the event of any claim or demand being made or action sought against Owner in respect of any of the aforesaid matter, the vendor shall be notified thereof immediately and the vendor shall at his/its own expense with (if necessary) the assistance of Owner (whose all expense shall be reimbursed by the vendor) conduct all negotiations for the settlement of the same and/or litigation which may arise thereof.

25. **LIABILITY CLAUSE:** In case where it is necessary for employees or representatives of the Vendor to go upon the premises of owner, vendor agrees to assume the responsibility for the proper conduct of such employees/representatives while on said premises and to comply with all applicable Workmen s Compensation Law and other applicable Government Regulations and Ordinances and all plant rules and regulations particularly in regard to safety precautions and fire hazards. If this order requires vendor to furnish labour at site, such vendors workmen or employees shall under NO circumstances be deemed to be in owner s employment and vendor shall hold himself responsible for any claim or claims which they or their heirs, dependent or personal representatives, may have or make, for damages or compensation for anything done or committed to be done, in the course of carrying out the work covered by the purchase order, whether arising at owner s premises or elsewhere and agrees to indemnify the owner against any such claims, if made against the owner and all costs of proceedings, suit or actions which owner may incur or sustain in respect of the same.
26. **COMPLIANCE OF REGULATIONS:** Vendor warrants that all goods/Materials covered by this order have been produced, sold, dispatched, delivered and furnished in strict compliance with all applicable laws, regulations, labour agreement, working condition and technical codes and statutory requirements as applicable from time to time. The vendor shall ensure compliance with the above and shall indemnify owner against any actions, damages, costs and expenses of any failure to comply as aforesaid.
27. **REJECTION, REMOVAL OF REJECTED GOODS AND REPLACEMENT:** In case the testing and inspection at any stage by inspectors reveal that the equipment, materials and workmanship do not comply with specification and requirements, the same shall be removed by the vendor at his/its own expense and risk, within the time allowed by the owner/purchaser. The Purchaser shall be at liberty to dispose off such rejected goods in such manner as he may think appropriate, in the event the vendor fails to



DELHI AVIATION FUEL FACILITY PRIVATE LIMITED

remove the rejected goods within the period as aforesaid. All expenses incurred by the Purchaser for such disposal shall be to the account of the vendor. The freight paid by the purchaser, if any, on the inward journey of the rejected materials shall be reimbursed by the vendor to the purchaser before the rejected materials are removed by the vendor. The vendor will have to proceed with the replacement of the Equipments without claiming any extra payment if so required by the purchaser. The time taken for replacement in such event will not be added to the contractual delivery period.

28. NON-WAIVER : Failure of the Owner to insist upon any of the terms or conditions incorporated in the Purchase Order or failure or delay to exercise any rights or remedies herein, or by law or failure to properly notify Vendor in the event of breach, or the acceptance of or payment of any goods hereunder or approval of design shall not release the Vendor and shall not be deemed a waiver of any right of the Owner to insist upon the strict performance thereof or of any of its or their rights or remedies as to any such goods regardless of when such goods are shipped, received or accepted nor shall any purported oral modification or revision of the order by DAFFPL act as waiver of the terms hereof. Any waiver to be effective must be in writing. Any lone incident of waiver of the any condition of this agreement by DAFFPL shall not be considered as a continuous waiver or waiver for other condition by DAFFPL.

29. NEW & UNUSED MATERIAL: All the material supplied/used by the vendor shall be branded new, unused and of recent manufacture.

30. CANCELLATION:

- a) DAFFPL reserves the right to cancel the contract/purchase order or any part thereof through a written notice to the vendor if –
 - i. The vendor fails to comply with the terms of this purchase order/contract.
 - ii. The vendor becomes bankrupt or goes into liquidation.
 - iii. The vendor fails to deliver the goods on time and/or replace the rejected goods promptly.
 - iv. The vendor makes a general assignment for the benefit of creditors.
 - v. A receiver is appointed for any of the property owned by the vendor.
 - vi. Any other conditions where owners commercial interest get affected.



DELHI AVIATION FUEL FACILITY PRIVATE LIMITED

b) Upon receipt of the said cancellation notice, the vendor shall discontinue all work on the purchase order matters connected with it. DAFFPL in that event will be entitled to procure the requirement in the open market and recover excess payment over the vendor's agreed price if any, from the vendor and also reserving to itself the right to forfeit the security deposit if any, made by the vendor against the contract. The vendor is aware that the said goods are required by DAFFPL for the ultimate purpose of materials production and that non-delivery may cause loss of production and consequently loss of profit to the DAFFPL. In this event of DAFFPL exercising the option to claim damages for non-delivery other than by way of difference between the market price and the contract price, the vendor shall pay to DAFFPL, fair compensation to be agreed upon between DAFFPL and the vendor. The provision of this clause shall not prejudice the right of DAFFPL from invoking the provisions of price reduction clause mentioned aforesaid.

31. **ANTI –COMPETITIVE AGREEMENTS/ABUSE OF DOMINANT POSITION:** The Competition Act, 2002 as amended by the Competition (Amendment) Act, 2007 (the Act), prohibits anti-competitive laws and aims at fostering competition and at protecting Indian markets against anti-competitive practices by enterprises. The Act prohibits anti-competitive agreements, abuse of dominant position by enterprises, and regulates combinations (consisting of acquisition, acquiring of control and M&A) wherever such agreements, abuse or combination causes, or is likely to cause, appreciable adverse effect on competition in markets in India. DAFFPL reserves the right to approach the Competition Commission established under the Act of Parliament and file information relating to anti-competitive agreements and abuse of dominant position. If such a situation arises, then Vendors are bound by the decision of the Competitive Commission and also subject to penalty and other provisions of the Competition Act.
32. **ASSIGNMENT:** The Vendor can / does not have any right to assign his rights and obligations under these general purchase conditions without the prior written approval of DAFFPL.
33. **GOVERNING LAW:** These General Purchase Conditions shall be governed by the Laws of India.
34. **AMENDMENT:** Any amendment to these General Purchase Conditions can be made only in writing and with the mutual consent of the parties to



these conditions.

35. The following expressions used in these terms and conditions and in the purchase order shall have the meaning indicated against each of these:
- a) **OWNER**, Client, Purchaser, buyer means DAFFPL
 - b) **VENDOR**, tenderer, Bidder, Contractor, Seller, Supplier, manufacturer stated anywhere in the tender document carry the same meaning: It means the person, firm or the Company / Corporation to bidding and shall include its successors and assigns.
 - c) **INSPECTOR/ TPIA**: Person/agency deputed by Owner for carrying out inspection, checking/testing of items ordered and for certifying the items conforming to the purchase order specifications.
 - d) **GOODS / MATERIALS**: means any of the articles, materials, machinery, equipment's, supplies, drawing, data and other property and all services including but not limited to design, delivery, installation, inspection, testing and commissioning specified or required to complete the order.
 - e) **SITE / LOCATION**: means any Site where DAFFPL desires to receive materials anywhere in India as mentioned in tender.
 - f) **CONTRACT**, Order or Purchase Order/CALL-OFF means the agreement for supply of goods/ materials for required quantity between Owner and Vendor, for a fixed time on mutually agreed terms and conditions.
 - g) The term MR means Material Requisition containing technical requirements and scope of work (technical), GPC means General Purchase Conditions containing commercial terms & conditions, PO means Purchase order issued after award of contract incorporating agreed deviations in MR, ATC means Agreed Terms & Conditions , RFQ means Request For Quotation.
 - h) For the purpose of contract, the trade terms FOB, CFR and CIF, DAP shall have the meanings as assigned to them by INCOTERMS 2010 published by ICC, Paris.

36. REFERENCE FOR DOCUMENTATION:

The number and date of Collective Request for Quotation (CRFQ) must appear on all correspondence before finalization of Contract / Purchase Order.

After finalization of Contract / Purchase Order: The number and date of Contract /Purchase Order must appear on all correspondence, drawings, invoices, dispatch advice, (including shipping documents if applicable) packing list and on any documents or papers connected



with this order.

37. ARBITRATION

- a) Any 'dispute or difference of any nature whatsoever, any claim, cross-claim, counterclaim or set off of the Owner against the Consultant or regarding any right, liability, act, omission or account of any of the parties hereto arising out of or in relation to this agreement shall be referred to the Sole Arbitration of the nominated Director of the Owner or of some Officer of the Owner who may be nominated by the nominated Director. The consultant will not be entitled to raise any objection to any such arbitrator on the ground that the arbitrator is an officer of the Owner or that he has dealt with the matters to which the contract relates or that in the course of his duties as an Officer of the Owner, he had expressed view on all or any other matters in dispute or difference. In the event of the arbitrator to whom the matter is originally referred being transferred or vacating his office or being unable to act for any reason, the nominated Director as aforesaid at the time of such transfer, vacation of office or inability to act may in the discretion of the nominated Director designate another person to act as arbitrator in accordance with the terms of the agreement to the end and intent that the original Arbitrator shall be entitled to continue the arbitration proceedings notwithstanding his transfer or vacation of office as an officer of the Owner if the nominated Director does not designate another person to act as arbitrator on such transfer, vacation of office or inability of original arbitrator. Such person shall be entitled to proceed with the reference from the point at which it was left by his predecessor. It is also a term of this contract that no person other than the nominated Director of the Owner or a person nominated by such nominated Director as aforesaid shall act as arbitrator hereunder. The award of the arbitrator so appointed shall be final, conclusive and binding on all parties to the agreement subject to the provisions of the Arbitration & Conciliation Act, 1996 or any statutory modification or reenactment thereof and the rules made there under for the time being in force shall apply to the arbitration proceedings under this clause.
- b) The arbitrator shall have power to order and direct either of the parties to abide by, observe and perform all such directions as the arbitrator may think fit having regard to the matters in difference i.e. dispute, before him. The arbitrator shall have all summary powers and may take such evidence oral and/or documentary, as the



DELHI AVIATION FUEL FACILITY PRIVATE LIMITED

arbitrator in his absolute discretion thinks fit and shall be entitled to exercise all powers under the Indian Arbitration & Conciliation Act 1996 including admission of any affidavit as evidence concerning the matter in difference i.e. dispute before him.

- c) The parties against whom the arbitration proceedings have been initiated, that is to say, the Respondents in the proceeding, shall be entitled to prefer a cross claim, counter claim or set off before the Arbitrator in respect of any matter in issue arising out of or in relation to the Agreement without seeking a formal reference of arbitration to the nominated Director/officer for such counter-claim, or set off and the Arbitrator shall be entitled to consider and deal with the same as if the matters arising therefore has been referred to him originally and deemed to form part of the reference made by the nominated Director/officer.
- d) The arbitrator shall be at liberty to appoint, if necessary any accountant or engineering or other technical person to assist him, and to act by the opinion so taken.
- e) The arbitrator shall have power to make one or more awards whether interim or otherwise in respect of the dispute and difference and in particular will be entitled to make separate awards in respect of claims of cross claims of the parties.
- f) The arbitrator shall be entitled to direct any one of parties to pay the costs to the other party in such manner and to such extent as the arbitrator may in his discretion determine and shall also be entitled to require one or both the parties to deposit funds in such proportion to meet the arbitrators expenses whenever called upon to do so.
- g) The parties hereby agree that the courts in the city of Delhi alone shall have jurisdiction to entertain any application or other proceedings in respect of anything arising under this agreement and any award or awards made by the Sole Arbitration hereunder shall be filed (if so required) in the concerned courts in the city of Delhi only.



DAFFPL
Let's fly High together!
(A JV of IOCL, BPCL and DIAL)

Delhi Aviation Fuel Facility Private Limited



Project Name

Supply of Expansion Bellows at Delhi Aviation Fuel Farm Facility Pvt. Ltd.

Document No.



DAFFPL-SGC-MR-0007

Rev.

00

MATERIAL REQUISITION FOR EXPANSION BELLOWS

Rev	Date	Description	Prepared	Reviewed	Approved	Client Review
0	10-05-2022	Issued For Tender	DR	AP	SKJ	

	Delhi Aviation Fuel Facility Private Limited			
Project Name	Supply of Expansion Bellows at Delhi Aviation Fuel Farm Facility Pvt. Ltd.			
Document No.	DAFFPL-SGC-MR-0007	Rev.	00	

Sr. No.	Item Description	Ref.	Qty.
1	EXPANSION BELLOWS: 16" (400 NB) Tied Double Metal Bellows Expansion Joint, API 5L GR.X42 SAW	Datasheet and Technical Specifications	6

Annexure No.	Description
A	TECHNICAL SPECIFICATIONS FOR EXPANSION BELLOWS
B	TYPICAL SKETCH FOR EXPANSION BELLOWS
C	DATASHEET FOR EXPANSION BELLOWS



DAFFPL
Let's fly High together!
(A JV of IOCL, BPCL and DIAL)

Delhi Aviation Fuel Facility Private Limited



Project Name

Supply of Expansion Bellows at Delhi Aviation Fuel Farm Facility Pvt. Ltd.

Document No.

DAFFPL-SGC-MR-0007



Rev.

00

ANNEXURE- A

SPECIFICATIONS FOR EXPANSION BELLOWS

Rev	Date	Description	Prepared	Reviewed	Approved	Client Review
0	10-05-2022	Issued for Tender	DR	AP	SKJ	

	Delhi Aviation Fuel Facility Private Limited		
Project Name	Supply of Expansion Bellows at Delhi Aviation Fuel Farm Facility Pvt. Ltd.		
Document No.	DAFFPL-SGC-MR-0007	Rev.	00

SPECIFICATION SHEET - TIED DOUBLE METAL BELLOWS EXPANSION JOINT

General:

Quantity: **6 Nos** Pipe Size: **16” (400NB)**
Overall length: **1100mm** Installation: **Horizontal**
Type: **Tied Double Metal Bellows Expansion Joint**
 (Check one) Equalizing Non Equalizing

Applicable sketch no: **As per Enclosed Sketch**

Design:

Service / Flow Medium : ATF	Rated for Flow : 600 KL / hr.
Attached Line Material : API 5L GR. X42 SAW	Corrosion allowance : 2.0 mm
Operating / Design Pressure: 7 kg/cm²g 15kg/cm²g	Temperature (max) : 100 °C
Short Time Pressure :	Temperature (min) : -5 °C



Type of Short time condition:

Less than 10 hours at any time 100 hour
 Less than 50 hours at any time 500 hour
Internal Lining required? Yes No
(If Yes): Material - **API 5L GR.X42 SAW** Minimum Thickness: 12.7 mm
Movements Axial: **15 mm Within tie-rod** Lateral offset: 75mm

Notes: **See Special Notes**

Allow Axial Stiffness (K): **1247 kg/cm**
Allow Trans lateral Stiffness (K): **43722 kg/cm**
Allow Torsional Stiffness (K): **72958 kg-m/deg.**
VALUES PROPOSED BY SUPPLIER SHALL BE CHECKED FOR ACCEPTABILITY IN STRESS ANALYSIS

<u>Upstream Connection: From Tank</u>	<u>Downstream Connection: From Header</u>
Size: 16”	Size 16”
Rating/ End: 150# WNRF, As per ASME B16.5	Rating/ End: 150# WNRF, As per ASME B16.5

	Delhi Aviation Fuel Facility Private Limited			
Project Name	Supply of Expansion Bellows at Delhi Aviation Fuel Farm Facility Pvt. Ltd.			
Document No.	DAFFPL-SGC-MR-0007	Rev.	00	

Bellows Material: **SS304L**

Minimum Thickness: **6mm**

Center Spool Material: **API 5L GR.X42 SAW**
(For Double Bellows)

Corrosion Allowance: **2.0mm**

External Shield for operation required? **YES - Removable Type (See Note 12)**

Minimum Design Cycles: **7000 Cycles per ASME B31.3 Appendix 'X'**

Design, Fabrication, Testing & Inspection

Code: **ASME B31.3 Latest Edition**

Pressure Test (By Manufacturer): **Hydro test of Bellows as per Code**

By Field: **None**



Weld Examination for Pressure containing or restraining parts: **Per Code B31.3**

External Shipping Shield Required for the Bellows (See Note 13): **Yes - Removable**

Identification Number: **Post Award of Order**

SPECIAL NOTES:

1. The Expansion Joint to be Clean and free from all loose material
2. The Expansion Joint Are to be supplied as separate items as shown in the attached sketch and in locked condition.
3. Design Conditions
Design Pressure: **15kg/cm²**
Design Temperature: **100 °C**
4. Material Specification
Bellow Material: **SS 304L**
Duct (Pipe): **API 5L GR.X42 SAW**
Stiffness: **ASTM A36**
Attachment Plates: **ASTM A 36**
5. Vendor Shall Furnish Calculations and detail fabrication drawing of expansion joint to purchaser for their approval
6. The Shipping and uncrated weight of the assembly shall be estimated within 5% and provided with quotation.
7. Temporary Shipping Restraints shall be adequately designed to withstand shipping and handling in Field
8. All internal welds to be ground smooth and Flush
9. Lifting Lugs to be supplied by vendor

	Delhi Aviation Fuel Facility Private Limited			
Project Name	Supply of Expansion Bellows at Delhi Aviation Fuel Farm Facility Pvt. Ltd.			
Document No.	DAFFPL-SGC-MR-0007	Rev.	00	

10. Coating System: **As per Manufacturer's Standard**

11. Bellows Internal liner shall be provided with Drain Holes

12. External Cover shall be strong enough to provide protection during Transportation, Handling, Field Storage and Installation.



DAFFPL
Let's fly High together!
(A JV of IOCL, BPCL and DIAL)

Delhi Aviation Fuel Facility Private Limited



Project Name

Supply of Expansion Bellows at Delhi Aviation Fuel Farm Facility Pvt. Ltd.

Document No.

DAFFPL-SGC-MR-0007



Rev.

00

ANNEXURE- B

TYPICAL SKETCH FOR EXPANSION BELLOW

0	10-05-2022	Issued For Tender	DR	AP	SKJ	
Rev	Date	Description	Prepared	Reviewed	Approved	Client Review

	Delhi Aviation Fuel Facility Private Limited			
Project Name	Supply of Expansion Bellows at Delhi Aviation Fuel Farm Facility Pvt. Ltd.			
Document No.	DAFFPL-SGC-MR-0007	Rev.	00	

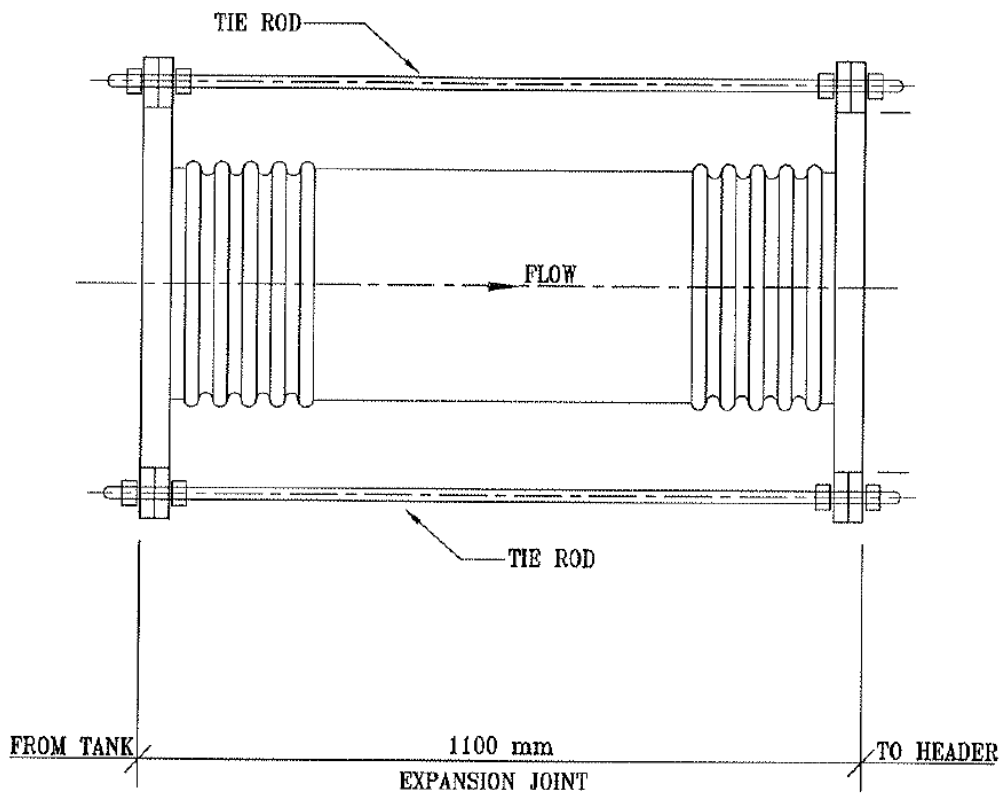

SIZE 16" O/D, Flanged END 150# AS PER ASME B16.5



Let's fly High together!
(A JV of IOCL, BPCL and DIAL)

Delhi Aviation Fuel Facility Private Limited



Project Name

Supply of Expansion Bellows at Delhi Aviation Fuel Farm Facility Pvt. Ltd.

Document No.

DAFFPL-SGC-MR-0007



Rev.

00



ANNEXURE- C

DATASHEET FOR EXPANSION BELLOW

0	10-05-2022	Issued For Tender	DR	AP	SKJ	
Rev	Date	Description	Prepared	Reviewed	Approved	Client Review

	Delhi Aviation Fuel Facility Private Limited		
Project Name	Supply of Expansion Bellows at Delhi Aviation Fuel Farm Facility Pvt. Ltd.		
Document No.	DAFFPL-SGC-MR-0007	Rev.	00

<u>DATASHEET FOR EXPANSION BELLOWES</u>		
GENERAL		
1	ITEM NO. / TAG NO.	
2	NOMINAL SIZE (NB) (PIPES)	16 inch, Sch 30
3	OD SIZE (NB) (PIPES)	406.4
4	QUANTITY	6 Nos.
5	TYPE OF EXPANSION JOINTS	Tied Double Metal Bellows Expansion Joint
6	INSTALLATION POSITION	Horizontal
FLUID INFORMATION		
7	MEDIUM	Petroleum Product (ATF)
8	VELOCITY	1.5 - 4 m/sec
SERVICE DATA		
9	WORKING TEMPERATURE (C)	50 °C
10	WORKING PRESSURE	7 Kg/cm ²
DESIGN DATA		
11	DESIGN TEMPERATURE (C)	100 °C
12	DESIGN PRESSURE	15 Kg/cm ²
13	TEST PRESSURE	As per the Code
MOVEMENTS		
14	AXIAL EXTENSION (mm)	See Specifications
15	AXIAL COMPRESSION (mm)	See Specifications
16	LATERAL DEFLECTION (mm)	Vendor to specify
17	ANGULAR ROTATION (deg)	Left 5 (deg), Right 5 (deg)
DIMENSIONAL LIMITATION (Deg)		
18	OVERALL LENGTH (FOR PIPE)	1100 Mm (Positive Tolerance only)
19	OUTSIDE DIAMETER (mm)	Vendor to specify
20	INSIDE DIAMETER (mm)	Vendor to specify
END CONNECTION DETAIL		
21	FLANGED	ASME B 16.5 WNRF with HUB
22	FLANGED RATING	150#
23	WELDABLE END	Both side flanges
24	PIPE O.D. X THK	406.4 MM x 9.53 MM
MATERIAL OF CONSTRUCTION		
25	BELLOWS	SS304L
26	LINER/ INTERNAL SLEEVE	API 5L GR.X42 SAW
27	WELDABLE END	Flange Connection
28	FLANGES	A105
29	EXTERNAL COVER	Stainless steel
30	TIE/LIMIT ROD	Vendor to propose
SPRING RATE LIMITATIONS		
31	AXIAL (kg/mm)	Refer Specifications
32	LATERAL (kg/mm)	Refer Specifications

	Delhi Aviation Fuel Facility Private Limited			
Project Name	Supply of Expansion Bellows at Delhi Aviation Fuel Farm Facility Pvt. Ltd.			
Document No.	DAFFPL-SGC-MR-0007	Rev.	00	

33	ANGULAR (kg/mm)	Refer Specifications
MISCELLANEOUS		
34	INSPECTION BY	Vendor to propose
35	MINIMUM DESIGN CODE	7000 Cycles as per ASME B31.3, Appendix X
36	DESIGN CODE	EJMA Code



DELHI AVIATION FUEL FACILITY PRIVATE LIMITED

ANNEXURE II – DEVIATION SHEET

EXCEPTION AND DEVIATIONS STATEMENT				
S.NO.	PAGE NO. OF TENDER DOCUMENT	CLAUSE NO.	SUBJECT	DEVIATIONS

Bidder shall list all the deviations in the following given format only on their Letterhead. The Deviation sheet should be submitted along with technical bid.

In case no deviation sheet is submitted along with technical bid, it would be concluded that bidder has accepted all specifications, terms and conditions.

Sign & Stamp of Bidder



DELHI AVIATION FUEL FACILITY PRIVATE LIMITED

ANNEXURE III – DECLARATION SHEET

Date:

DECLARATION

We, M/s _____ hereby, unconditionally accept all terms & conditions of TENDER NO.: DAFFPL/FF/2022-23/02 (JOB: TENDER FOR SUPPLY of 16" EXPANSION JOINT (TIED DOUBLE METAL BELLOW EXPANSION JOINT)AT DAFFPL) including Scope of job, quantities, completion period, terms & condition without any deviations.

Sign & Stamp of Bidder

Note: In case of deviations (whether technical or commercial) the above declaration should not be submitted, and the deviations should be mentioned separately on bidders letter head with the heading "DEVIATION SHEET". In absence of "DEVIATION SHEET", it would be concluded that bidder has submitted his offer as per tender specifications, terms & conditions. Corrections in tender booklet will not be accepted.

Sign & Stamp of Bidder



DELHI AVIATION FUEL FACILITY PRIVATE LIMITED

ANNEXURE-IV

PROFORMA OF BANK GUARANTEE (EARNEST MONEY DEPOSIT)

(On Non-Judicial Stamp paper for appropriate value)

BANK GUARANTEE NO. :

BANK GUARANTEE AMOUNT:

CLAIM:

(Till 120 days from date of submission of Proposal)

TENDER NO. /DATE:

JOB DESCRIPTION/

LOCATION:

Tender Security No. [*]

Name and Address of the Beneficiary: Delhi Aviation Fuel Facility (Private) Limited
Aviation Fuelling Station, Shahabad Mohammadpur, IGI Airport, New Delhi – 110 061, India

We [*name and address of the issuing bank*] have been informed that [*Name of the Interested party*] (hereinafter called the “Interested Party”) is submitting a proposal for the Award of the Works in response to a Request for Proposal (“RFP”) by Delhi Aviation Fuel Facility (P.) Ltd. (“DAFFPL” or ‘Beneficiary’) for [*Insert description of work*] (“Works”). The conditions of the RFP, which are set out in a documents entitled Request for Proposal dated [*Please insert*] require its offer to be supported by a Tender Security.

At the request of the Interested Party, we hereby irrevocably undertake to pay you without demur, the Beneficiary, any sum or sums not exceeding Rs. _____ [*Please insert*].

Upon receipt by us of your demand in writing and your written statement (in the demand) stating that:

- 1) The Interested Party has, without written consent of DAFFPL, withdrawn its offer after the latest time specified for its submission and before the expiry of its period of validity; or
- 2) The Interested Party has refused to accept the correction of errors in nits offer in accordance with the instructions to Interested parties contained in the RFP; or

Sign & Stamp of Bidder



DELHI AVIATION FUEL FACILITY PRIVATE LIMITED

- 3) DAFFPL entered in to the contract with the Interested party but the Interested party has failed to deliver the **COMPOSITE BANK GUARANTEE (SECURITY DEPOSIT & PERFORMANCE)** in compliance with the Contract conditions; or
- 4) The Interested Party has failed to enter into the Contract within 30 (Thirty) days of being required to do so by the Tender Officer.

Any demand for payment must contain your signature(s). The demand must be received by us at this office on or before the expiry of the earliest of the following dates, when this security guarantee shall expire and shall be returned to us:

- a) Date of issue of letter communicating to the Interested Party that it has not qualified for the contract or the Proposal submitted by the Interested Party is unsuccessful or the TENDER is withdrawn and/or cancelled by the Beneficiary; or
- b) 7 (seven) days after the date of delivery of an acceptable performance bond complying with the Contract conditions and execution of the Contract after the award of the works to the Interested Party; or
- c) 120 (One hundred twenty) days from the last date of submission of Proposal in accordance with the TENDER.

Date:

Signature:

Designation:

Name of the Branch

Sign & Stamp of Bidder



DELHI AVIATION FUEL FACILITY PRIVATE LIMITED

ANNEXURE-V

PROFORMA OF COMPOSITE BANK GUARANTEE (SECURITY DEPOSIT & PERFORMANCE)

(On Non-Judicial paper of Rs. 100/-value)

To,

DAFFPL

Dear Sirs,

M/shave taken tender for the workfor DAFFPL,.

The tender Conditions of Contract provide that the Contractor shall pay a sum of Rs. (Rupees) as security deposit & performance guarantee in the form therein mentioned. The form of payment of security deposit & performance guarantee includes guarantee executed by Scheduled Bank at New Delhi, undertaking full responsibility to indemnify DAFFPL, in case of default. The said party have approached us at and their request and in consideration of the premises we having our office at have agreed to give such guarantees as hereinafter mentioned.

1. We -----hereby undertake and agree with you that if default shall be made by M/s. -----in performing any of the terms and conditions of the tender or in payment of any money payable to Daffpl. We shall on demand pay to you, without demur, protest or requiring you to seek recourse to M/s _____, in such matter as to you may direct the said amount of Rupees ----- only or such portion thereof not exceeding the said sum as you may from time to time require.
2. You will have the full liberty without reference to us and without effecting this guarantee, postpones for any time or from time to time the exercise of any of the powers and rights conferred on you under the contract with the said -----and to enforce or to forbear from endorsing any powers of rights or by reason of time being given to the said -----which under law relating to the sureties would but for provision have the effect of releasing us.
3. Your right to recover the said sum of Rs. ----- (Rupees -----) from us in manner aforesaid will not be affected or suspended by reason of the fact that any dispute or disputes have been raised by the said M/s. -----

Sign & Stamp of Bidder



DELHI AVIATION FUEL FACILITY PRIVATE LIMITED

- and/or that any dispute or disputes are pending before any officer, tribunal or court.
4. The guarantee herein contained shall not be determined or affected by the liquidation or winding up dissolution or change of constitution or insolvency of the said -----but shall in all respect and for all purposes be binding operative units payment of all money due to you in respect of such liabilities is paid.
 5. Our liability under this guarantee is restricted to Rupees -----our guarantee shall remain in force until -----unless a suit or action to enforce a claim under Guarantee is filed against us within six months from -----(which is date of expiry of guarantee) all our rights under the said guarantee shall be forfeited and we shall be relieved and discharged from all liabilities there under.
 6. NOT WITHSTANDING anything hereinbefore contained our liability under this Bank Guarantee is restricted to Rupees -----(Rupees -----).This Bank Guarantee shall be valid up to -----and we are liable to pay the guaranteed amount or any part thereof under this Bank Guarantee only and only if you serve upon us a written claim or demand on or before -----.
 7. This guarantee is to be returned to us within fifteen (15) days from the date it ceases to be in force. If the guarantee is not returned to us within the date of aforementioned it shall be automatically cancelled.
 8. We have power to issue this guarantee in your favour under Memorandum and Articles of Association and the undersigned has full power to do under the Power of Attorney dated -----granted to him by the Bank.

Yours faithfully

-----Bank
By its Constituted Attorney
Signature of a person duly
Authorized to sign on behalf of the bank

Sign & Stamp of Bidder



DELHI AVIATION FUEL FACILITY PRIVATE LIMITED

Annexure- VI

Form of Letter of Undertaking

[On the letterhead of the Interested Party]

Letter of Undertaking

Date:

Delhi Aviation Fuel Facility (Private) Limited
Aviation Fuelling Station, Shahabad Mohammadpur,
IGI Airport, New Delhi – 110 061, India

Re:

The undersigned Interested Party acknowledges that the TENDER issued is confidential and personal to the undersigned Interested Party and hereby undertakes and agrees as follows:

1. **“Confidential Information”** means the TENDER and everything contained therein, all documentation, data, particulars of the Works and technical or commercial information made by (or on behalf of) Delhi Aviation Fuel Facility (Private) Limited or obtained directly or indirectly from Delhi Aviation Fuel Facility (Private) Limited or its representatives by the undersigned Interested Party or which is generated by the undersigned Interested Party or any information or data that the undersigned Interested Party receives or has access to, as a result of the TENDER, as being confidential information of Delhi Aviation Fuel Facility (Private) Limited, provided that such term does not include information that (a) was publicly known or otherwise known to undersigned Interested Party prior to the time of such disclosure, (b) subsequently becomes publicly known through no act or omission by undersigned Interested Party or any person acting on its behalf.
2. The undersigned Interested Party shall maintain the confidentiality of Confidential Information in accordance with procedures adopted by the undersigned Interested Party in good faith to protect confidential information of third parties delivered to it, provided that the undersigned Interested Party may deliver or disclose Confidential Information to its authorized representatives who agree to hold confidential the Confidential Information substantially in accordance with the terms of this Undertaking.
3. The undersigned Interested Party shall not at any time whatsoever:
 - (i) Disclose, in whole or in part, any Confidential Information received directly or indirectly from the Delhi Aviation Fuel Facility (P) Limited to any third party.

Sign & Stamp of Bidder



DELHI AVIATION FUEL FACILITY PRIVATE LIMITED

(ii) Reproduce, publish, transmit, translate, modify, compile or otherwise transfer the Confidential Information.

4. In case the Proposal of the undersigned Interested Party is not accepted and immediately upon the acceptance of the Proposal of any of the other Interested Party, the undersigned Interested Party, shall:

(i) Return all Confidential Information including without limitation, all originals, copies, reproductions and summaries of Confidential Information; and

(ii) Destroy all copies of Confidential Information in its possession, power or control, which are present on magnetic media, optical disk or other storage device, in a manner that ensures that the Confidential Information is rendered unrecoverable.

5. The undersigned Interested Party shall certify to Delhi Aviation Fuel Facility (Private) Limited that it has returned or destroyed such Confidential Information to the Delhi Aviation Fuel (Private) Limited within two (2) days of such a request being made by Delhi Aviation Fuel (Private) Limited.

Name of Interested Party's

Signature of Authorized Representative

Sign & Stamp of Bidder



DELHI AVIATION FUEL FACILITY PRIVATE LIMITED

Annexure VII

DECLARATION to be submitted along with Technical Bid

(M/s. _____) hereby declare / clarify that we have not been banned or delisted by IOCL/BPCL/DIAL or any government or quasi Government agencies or Public Sector Undertakings.

Stamp & Signature of the bidder

NOTE: If a bidder has been banned by IOCL/BPCL/DIAL or any Government or quasi Government agencies or PSUs, this fact must be clearly stated with details. If this declaration is not given along with the technical bid, the tender will be rejected as non-responsive.

Sign & Stamp of Bidder



DELHI AVIATION FUEL FACILITY PRIVATE LIMITED

ANNEXURE VIII

STATEMENT OF CREDENTIALS

(A)

1. NAME AND CORRESPONDENCE ADDRESS OF THE TENDERER

PERMANENT ADDRESS OF THE TENDERER

2. TELEPHONE NO. _____

MOBILE NO. _____

3. NAME OF CONTACT PERSON(s): _____

4. NAME OF THE AUTHORISED SIGNATORY: _____

5. E Mail ID: _____

Sign & Stamp of Bidder



DELHI AVIATION FUEL FACILITY PRIVATE LIMITED

(B) TYPE OF BUSINESS ENTITY:

1. YEAR OF ESTABLISHMENT OF THE FIRM: _____

2. SOLE PROPRIETORSHIP: - _____

(Give Name of the Proprietor)

OR

3. PARTNERSHIP FIRM?

(Give names of the Partners and enclose scan copy of Partnership deed)

1. _____

2. _____

3. _____

4. _____

OR

4. PRIVATE OR PUBLIC LIMITED COMPANY?

(Attach list of Directors and copy of Certificate of Incorporation as defined in "Other Mandatory Documents")

(C) Details of Completed Purchase Orders of minimum value as per Pre-qualification criteria (PQC/BQC) during last SEVEN years as specified in PQC/BQC of the tender.

Sign & Stamp of Bidder



DELHI AVIATION FUEL FACILITY PRIVATE LIMITED

Sl. No	Particulars	1	2	3
a	Party's Name to whom supplied, Clear Postal Address, Telephone/Fax Nos and E-Mail Address.			
b	<u>Purchase Order Details-</u>			
	PO Reference No.			
	PO Date			
	PO Value (Rs. in Lakhs)			
c	Quantity & place of supply			
d	Scheduled time of completion as per PO			
e	Date of commencement of supply			
f	Date of completion of supply			
g	Completion certificate reference and date			

Note: a. Tenderer should furnish copy of the above-referred orders (as defined under PQC documents) and

b. Enclose a separate statement if space is not sufficient.

(D) **Annual Turnover (as per Audited Balance Sheet) in following last THREE financial years**

SL No.	Financial Year	Value (Rs. In Lakhs)
1	2019-2020	
2	2020-2021	
3	2021-2022	

Sign & Stamp of Bidder



DELHI AVIATION FUEL FACILITY PRIVATE LIMITED

Note : Tenderer should furnish copy of audited accounts as proof of turnover (as defined under tender documents).

(E) INCOME TAX DETAILS:

i. Income Tax Returns Filed:

ASSESSMENT YEAR	DATE	ACKNOWLEDGEMENT NO
2019-2020		
2020-2021		
2021-2022		

Note: Tenderer should furnish copy of the Income Tax Return filed.

ii. Income Tax Assessment Orders for following three financial years:

ASSESSMENT YEAR	ASSESSMENT ORDER & DATE	REMARKS
2019-2020		
2020-2021		
2021-2022		

Copies of Income Tax assessment orders / return filed / acknowledgement order for the three years as indicated above.

(F) GST Registration Details:

GST Registration no	
---------------------	--

Note: Tenderer should furnish copies of above Tax Registration Certificates.

Sign & Stamp of Bidder



DELHI AVIATION FUEL FACILITY PRIVATE LIMITED

(G) Mode of EMD (Online EMD or BG):

i. If paid Online:

AMOUNT	Rs.
(RTGS/NEFT/NET BANKING)	
Transaction Detail	

ii. If Bank Guarantee submitted (following details to be given) :

Name of the Issuing Bank and Branch Address	Bank Guarantee No and Date	BG Amount Rs.	Date of issuance	Valid Upto

(H) Production Capacity Details: (in case of manufacturer)

S. N	Item	Factory/ Location	Installed/ Capacity	Already Committed Capacity (For current Purchase orders in hand)	Spare Capacity, If Any	Capacity Committed to DAFFPL against this tender
			A	B	C=A-B	

Sign & Stamp of Bidder



DELHI AVIATION FUEL FACILITY PRIVATE LIMITED

Factory License and Address Details:

- (J) **In case the bidder is not a manufacturer, the bidder should submit an undertaking on Letter Head that the bidder is capable of supplying the material / equipment as per tender requirement.**

- (K) **Pan Card Details**

**Relation of Pan Holder to Tenderer
(PROP./PARTNER/COMPANY ETC.)
(Tenderer is required to upload copy of PAN card as detailed in "Other Mandatory documents")**

- (L) **Details of Documents uploaded along with Tender documents in technical bid and confirmation required to be furnished by tenderer.**

Sign & Stamp of Bidder



DELHI AVIATION FUEL FACILITY PRIVATE LIMITED

PAYMENT TO VENDORS THROUGH ELECTRONIC MODE

Tenderers are requested to submit their Consent Letter as per the format given below along with the enclosures as required:

Dated:

To,
M/s DAFFPL.

Dear Sir,

With reference to your advice, we hereby agree to accept the payment of our bills through "RTGS/NEFT/Electronic Mode". The desired bank account details are given below:

1.	Name of Beneficiary	
2.	Name of the Beneficiary's Bank	
3.	Address of the Beneficiary's Bank Branch	
4.	Contact details of Branch with STD Code	
5.	Beneficiary's Bank Account No. (as per cheque copy)	
6.	Beneficiary's Account Type (SB/CC/CA)	
7.	Beneficiary's Bank IFSC Code (11 Digit)	
8.	Mobile No of Beneficiary (One Number only)	
9.	E-Mail Id of Beneficiary (One Mail Id only)	

A blank cancelled cheque leaf relating to the above bank account is enclosed for verifying the accuracy of the bank account details.

I hereby declare that the particulars given above are correct and complete.

(Signature of Account Holder)

Seal of the Vendor

Encl: Cancelled Cheque

Sign & Stamp of Bidder